

PHF TB4040X60MM

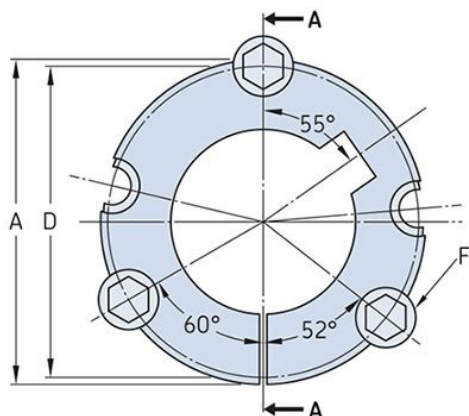

Bushing no.	TB4040
d = Bore diameter (mm)	60
Bore diameter (in)	2.36
Keyway width (mm)	18
Keyway width (in)	0.71
Keyway depth (mm)	4.4
Keyway depth (in)	0.17
A (mm)	146
A (in)	5.75
B (mm)	102
B (in)	4.02
D (mm)	141
D (in)	5.55
E (mm)	-
E (in)	-
F (mm)	15.875 x 44.45
F (in)	-
Weight (kg)	8.54
Weight (lbs)	18.83